



VĨNH HƯNG®



Vietnam Value

Proud to be
VIETNAM'S NATIONAL BRAND



A specialist transportation
mechanical manufacturer
from Vietnam

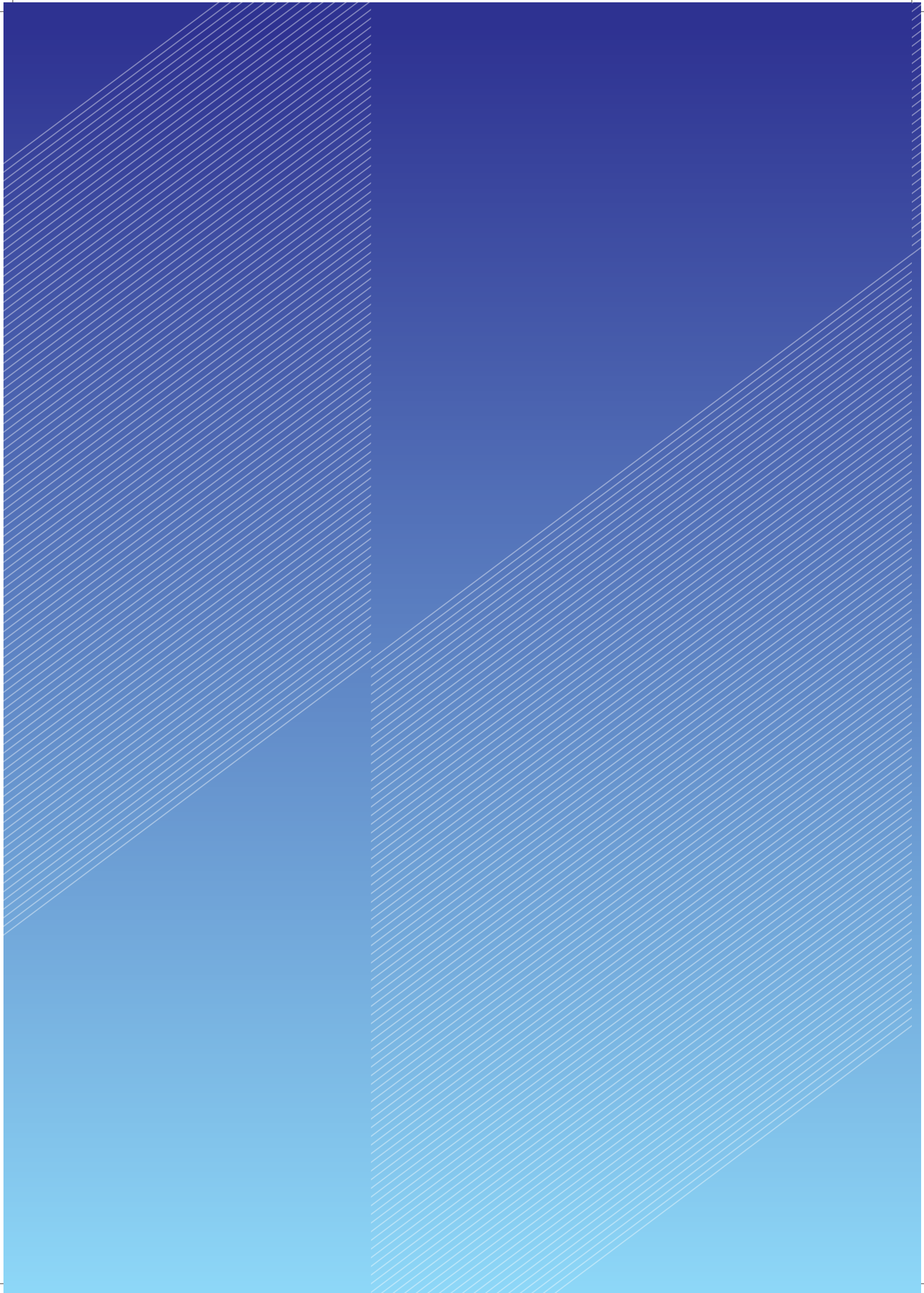

Table of contents

Introduction	4
Organizational structure	7
Company milestones and timeline	8
<hr/>	
PRODUCTS	11
1. Bridge bearings	12
2. Expansion joints	13
3. Noise barriers	14
4. Steel structures	15
<hr/>	
PRODUCTION CAPACITY	16
1. Hung Yen factory	18
2. Bac Ninh factory	22
3. Ho Chi Minh factory	26
4. Design and manufacturing standards	28
5. Quality control	30
<hr/>	
Typical export projects	34
Global partners	38
Why choosing us?	40

VINH HUNG JSC INTRODUCTION



VISION

The vision of Vinh Hung is to build a corporation with a diversified business system covering 3 core areas: Manufacturing, Construction, Trading in the field of transportation infrastructure, to be listed on the stock exchange, and recognized as a sustainable enterprise meeting ESG standards by 2030. Our traditional products (bridge bearings, expansion joints, noise barriers) are striven to rank top 3 in the market share of Southeast Asia region.



MISSION

Contribute to enhancing the country's image and position by providing advanced materials and technological solutions for typical transportation and infrastructure projects in Vietnam and the world.

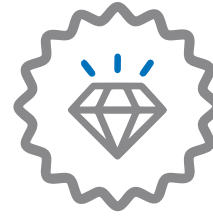

CORE VALUES

- Quality
- Solidarity
- Discipline
- Respect for individuality
- Responsibility



Vinh Hung's mission is to connect roads, contribute to opening up development opportunities for society, and create sustainable values for communities.

*Mr. Tran Duc Tien
Chairman of the Board of Directors*



MANAGEMENT SYSTEM

Vinh Hung is committed to prioritizing quality in all manufacturing and business decisions, meeting the strictest requirements of customers and projects.



Cebu - Cordova Link Expressway
The Philippines

1 ISO 9001 Quality Management System



2 ISO 14001 Environmental Management System



3 ISO 3834-2 Welding Quality Management System

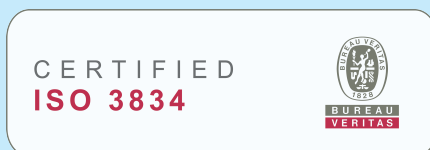

4 EN 1090 Structural Steel Product Quality Certification

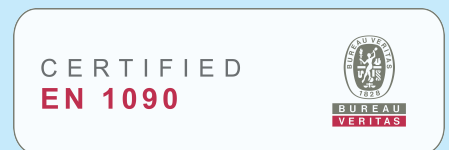

BUSINESS FIELDS

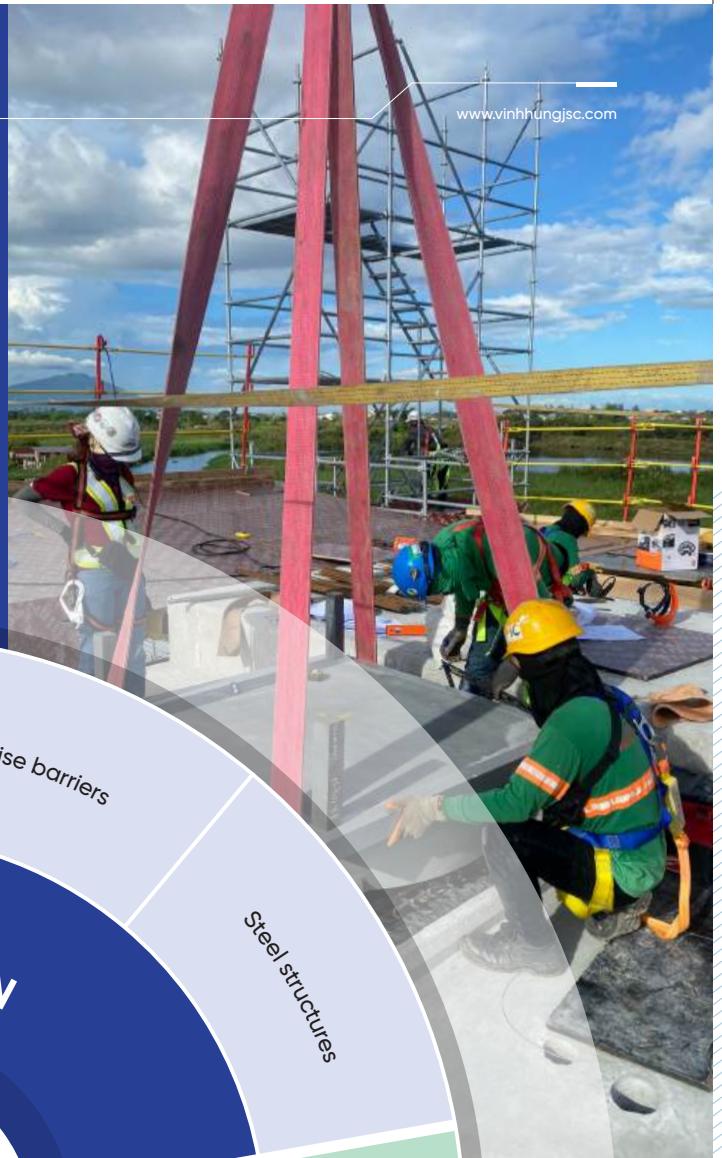
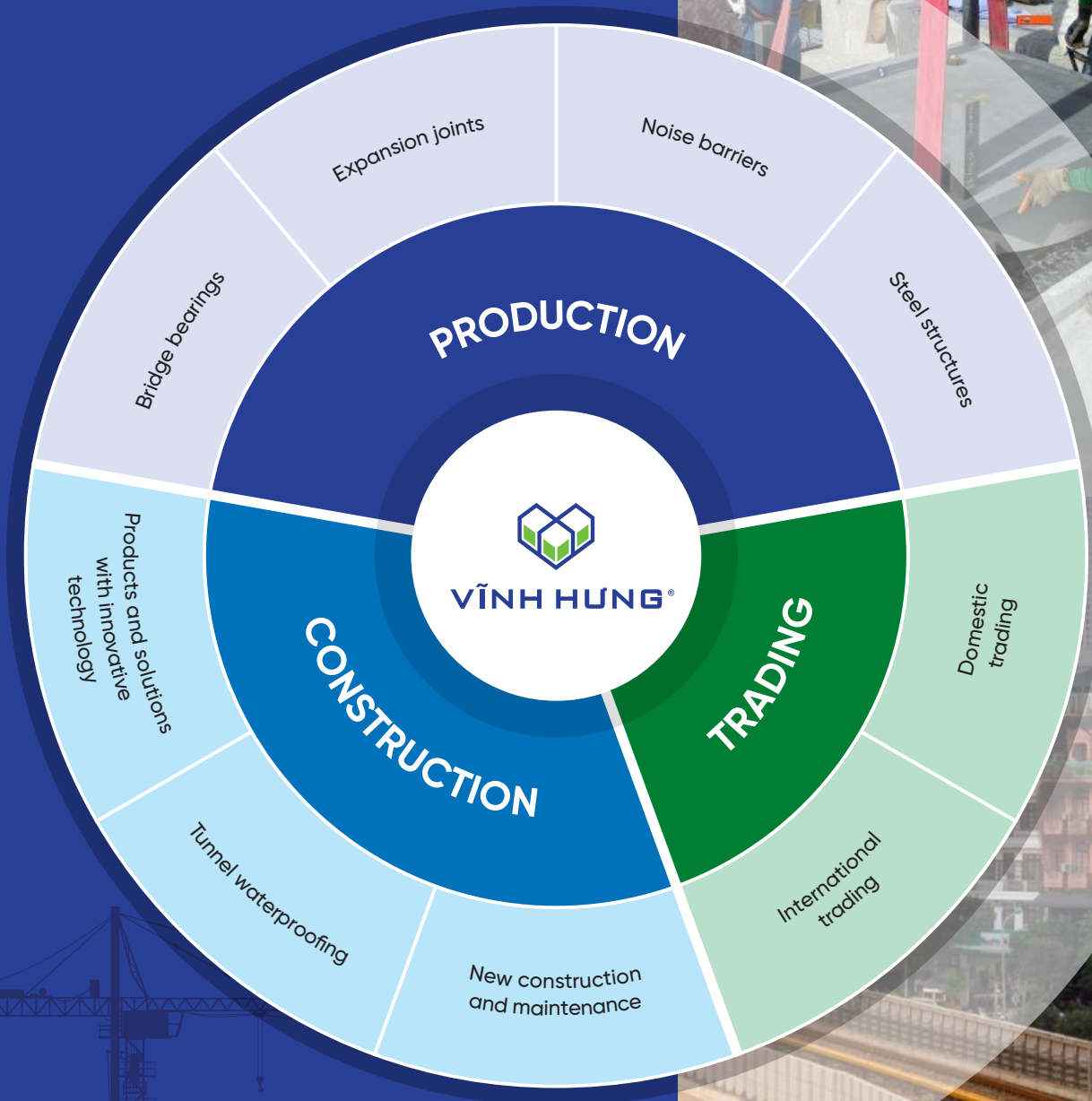



VĨNH HƯNG®

ORGANIZATIONAL STRUCTURE

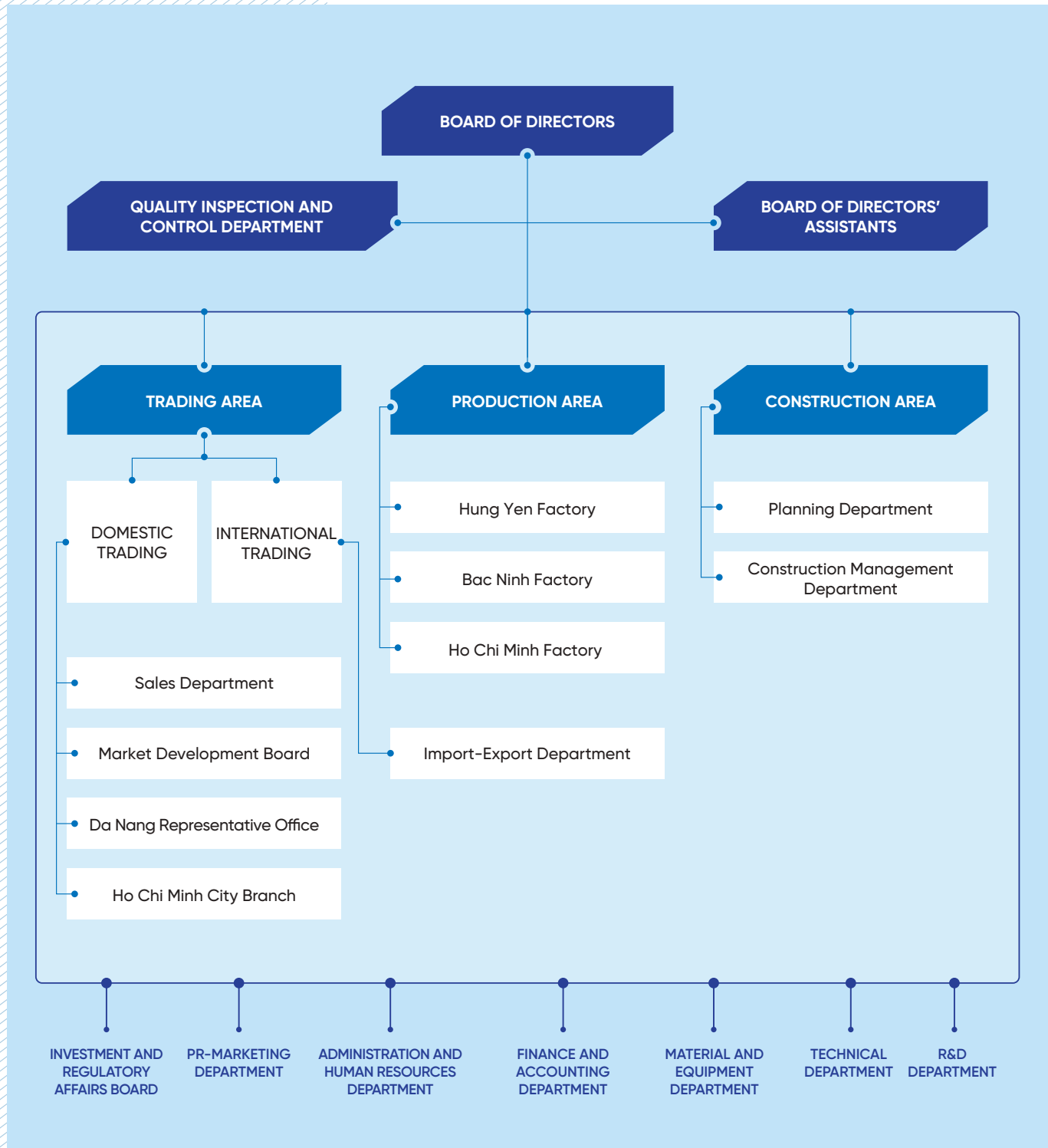

COMPANY MILESTONES AND TIMELINE

2006



- Establishment of Vinh Hung JSC.
- Supply construction materials for transportation, industrial and civil works.

2007 2010



- Exclusive distribution of Banh Pho bridge bearings and expansion joints, Quy Chau cables, and QVM anchors in Vietnam.
- Equipment supply and construction for typical projects: Lang - Hoa Lac highway expansion and completion project, Noi Bai - Lao Cai expressway, Long Thanh - Dau Giay expressway, etc.
- Establishment of Ho Chi Minh City Branch.
- Establishment of Ho Chi Minh factory
- Establishment of Bac Ninh factory

2011 2015



- Develop relationships with suppliers outside China such as: South Korea, Japan, Switzerland (DongIL, Shinsung, Kawakin, Mageba, etc.)
- The first waterproofing construction project was implemented at Trung Hoa interchange tunnel in Hanoi.
- Receive technology transfer and implement the construction of flexible expansion joints (FEBA joints), BEJ joints from USL - United Kingdom.
- Implement manufacturing, gradually localize bridge bearing and expansion joint products in Vietnam to replace imported sources.
- Some prominent projects: Ha Long - Hai Phong expressway, Hanoi - Hai Phong expressway, urban railway Nhon - Hanoi station, urban railway Cat Linh - Ha Dong, Nhat Tan Bridge, etc.
- Establishment of Representative Office in Da Nang



2016 2017

- Establishment of Hung Yen factory.
- Significant growth in construction field:
 - Expansion of waterproofing construction for projects such as Yen Phong tunnel, Dong Nai tunnel, The Manor Central Park project, etc.
 - Development of construction capabilities in diverse fields: replacing bridge structures, repairing bridge decks, waterproofing bridge surfaces, asphalt concrete pavement.
- Research and introduction of a range of products to the market such as Vinh Hung VHB pot bearing, VHM expansion joint, noise barrier, handrails, VHC spherical bearing.

2018 2019

- Commencement of export activities with the first project: Temburong Bridge (Brunei) - the longest sea-crossing bridge in Southeast Asia.
- Supply and construction of noise barriers in projects such as the Phap Van - Cau Gie expressway, Ha Long - Van Don expressway, and Bach Dang bridge.

2020 NOW

- Supply innovative technology solutions and products including rockfall prevention solutions, mechanically stabilised earth retaining walls, tied back gabions, cable bridge construction, noise barriers, etc.
- Develop waterproofing construction, new construction, repair and maintenance of transportation infrastructure.
- Export bridge bearings, expansion joints, handrails, noise barriers, etc. to Southeast Asia countries, including the 34,500 kN pot bearing type exported to the Philippines.
- Participating in various expressway and large bridge projects. Typical projects:
 - 11/11 sub-projects in the North-South Expressway phase 1, 12/12 sub-projects in the North - South Expressway phase 2, Phuoc An bridge, Rach Mieu bridge, Malolos - Clark Railway (The Philippines), etc.
- In 2024, Vinh Hung is proud to be recognized as "Vietnam National Brand" by the Government based on a system of criteria assessment on quality, innovation - creativity, and pioneering leadership in the industry.

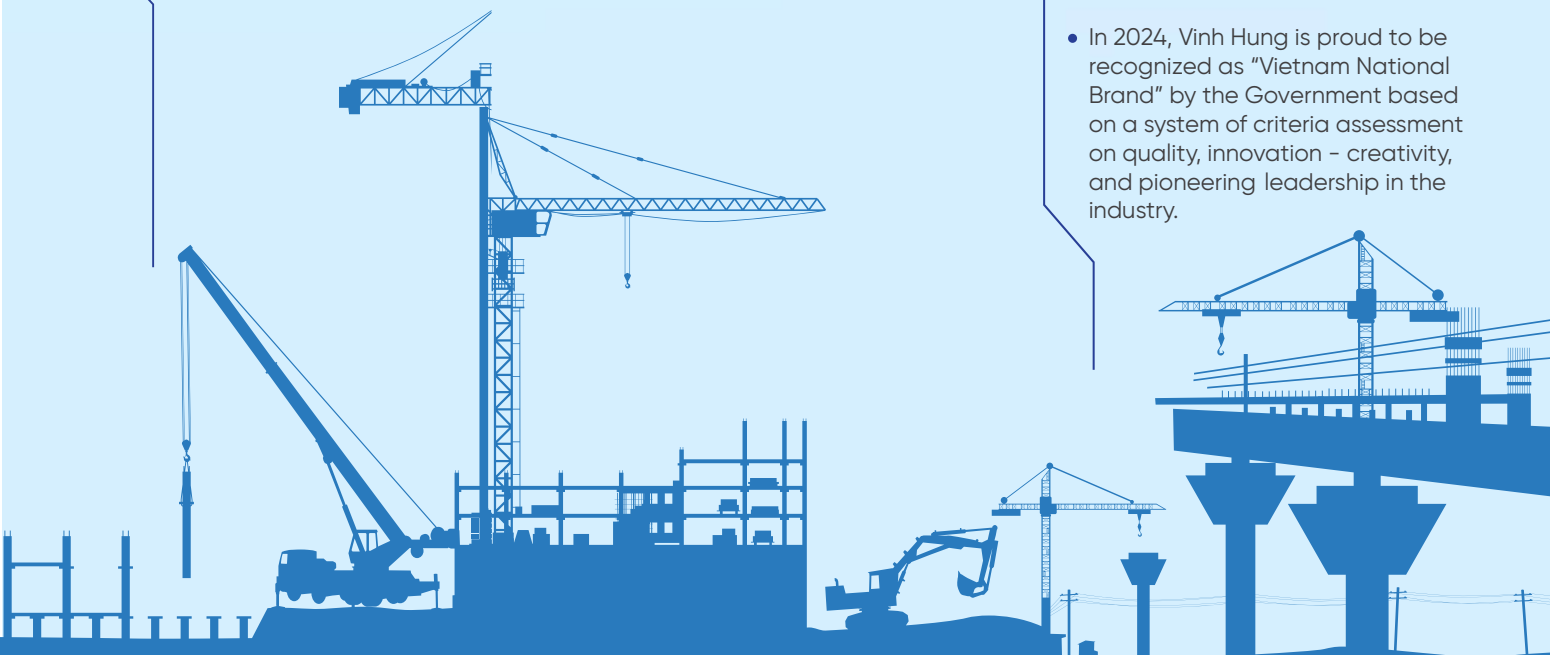



PRODUCTS

BRIDGE BEARINGS

EXPANSION JOINTS

NOISE BARRIERS

STEEL STRUCTURES



PRODUCTION

BRIDGE BEARINGS

PRODUCTS

1. Pot bearing
2. Spherical bearing
3. Disc bearing
4. Elastomeric bearing
5. Bearing for railways
6. Pendulum bearing

Vinh Hung is a pioneering Vietnamese brand in researching and investing in personnel and production lines to manufacture various types of bridge bearings with load capacity up to 60,000 kN, meeting international standards such as AASHTO LRFD, AASHTO M251, BS 5400, EN 1337, KS F4420, IRC 83, TCVN 10268:2014, TCVN 10308:2014, TCVN 11823:2017, and TCVN 12885:2020.

Vinh Hung's bridge bearings are strictly quality inspected throughout the manufacturing process and are tested from raw materials to finished products in the factory's laboratory to ensure the compliance with customer requirements or project specifications.

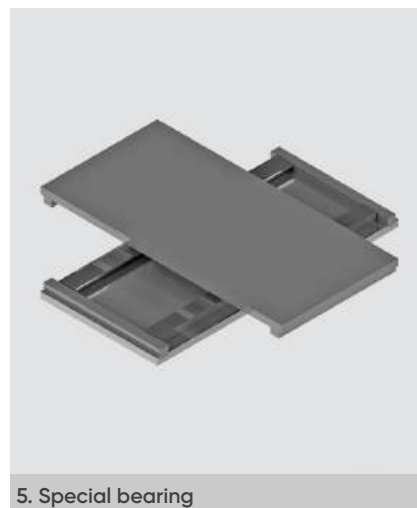
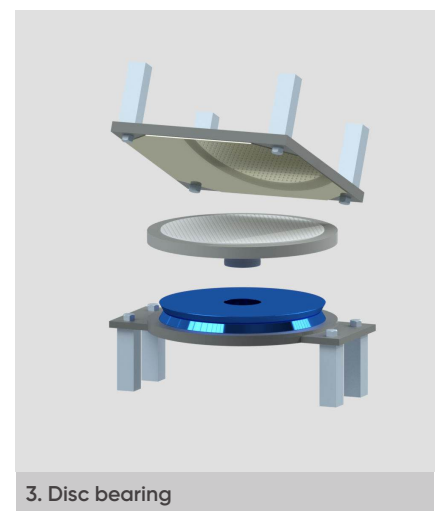

PRODUCTION

EXPANSION JOINTS

PRODUCTS

1. *Finger expansion joint*
(steel, aluminum alloy)

2. *Modular expansion joint*

3. *Strip-seal expansion joint*
(steel, aluminum alloy)

Vinh Hung's expansion joints are designed and manufactured in compliance with standards: AASHTO LRFD, ASTM D3542, TCVN 11823:2017, TCVN 12885:2020, TCVN 13067:2020, with high accuracy, stable structure, and convenience for installation, maintenance, or replacement of damaged expansion joints during operation.

Vinh Hung's expansion joints meet the requirements for both straight and skew bridge positions.

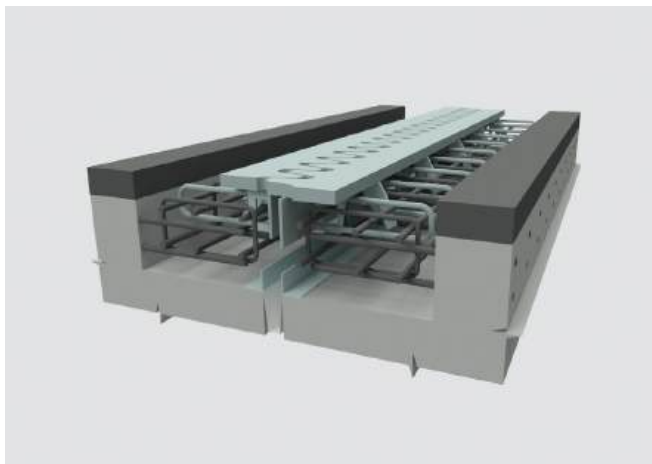

1. Finger expansion joint (steel, aluminum alloy)

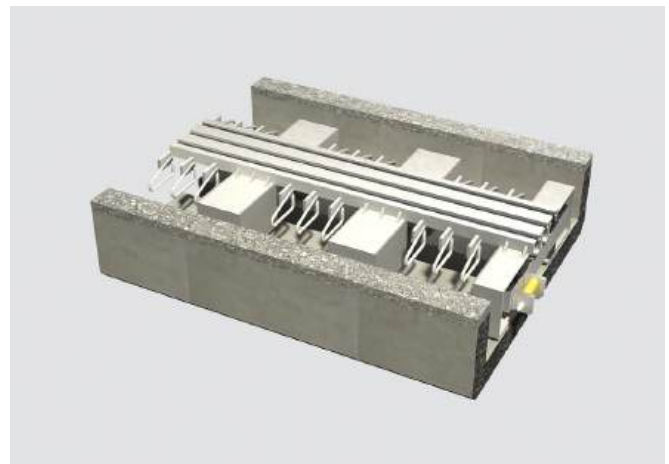

2. Modular expansion joint

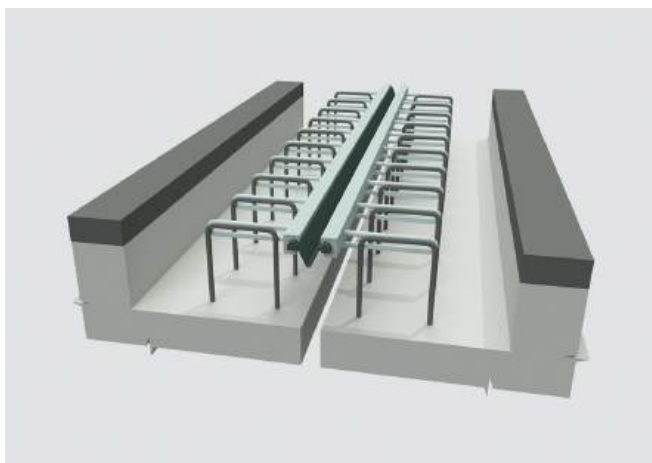

3. Strip-seal expansion joint (steel, aluminum alloy)



Quan Lo - Phung Hiep Route Upgrade Project
Vinh Hung manufactures and replaces expansion joints.

PRODUCTION

NOISE BARRIERS

PRODUCTS

1. *Absorptive noise barrier*
2. *Reflective noise barrier*

Vinh Hung's noise barriers are designed, manufactured, and constructed to meet current standards such as TCCS 45:2022/TCĐBVN, BS EN 14388, KS F4770, etc. and other international standards.

Noise barriers aim to minimize the impact of traffic noise on residential areas, hospitals, schools, industrial zones, etc. Vinh Hung's noise barriers may help to improve the urban landscape and transportation infrastructure thanks to the variety of materials.



1. *Phap Van - Cau Gie expressway*



2. *Hanoi's city elevated ring road No.2*

PRODUCTION

STEEL STRUCTURES

PRODUCTS

Vinh Hung has made a mark in successfully manufacturing and exporting steel structure products such as steel bridges, formworks, gantries, sign posts, seismic restrainers, handrails for different railway projects, expressways, and sea-crossing bridges, etc. in the region.

- 1. Steel bridge and steel box girder
- 2. Station steel structure and roof covering
- 3. Other steel structures for transportation construction



1. Steel bridge and steel box girder



2. Station steel structure and roof covering

- 3. Other steel structures for transportation construction



Seismic restrainer



Handrail



Gantry and sign post



Moulds & Formwork travelers

PRODUCTION CAPACITY

- ▣ HUNG YEN FACTORY
- ▣ BAC NINH FACTORY
- ▣ HO CHI MINH FACTORY
- ▣ MANAGEMENT SYSTEM
- ▣ QUALITY CONTROL

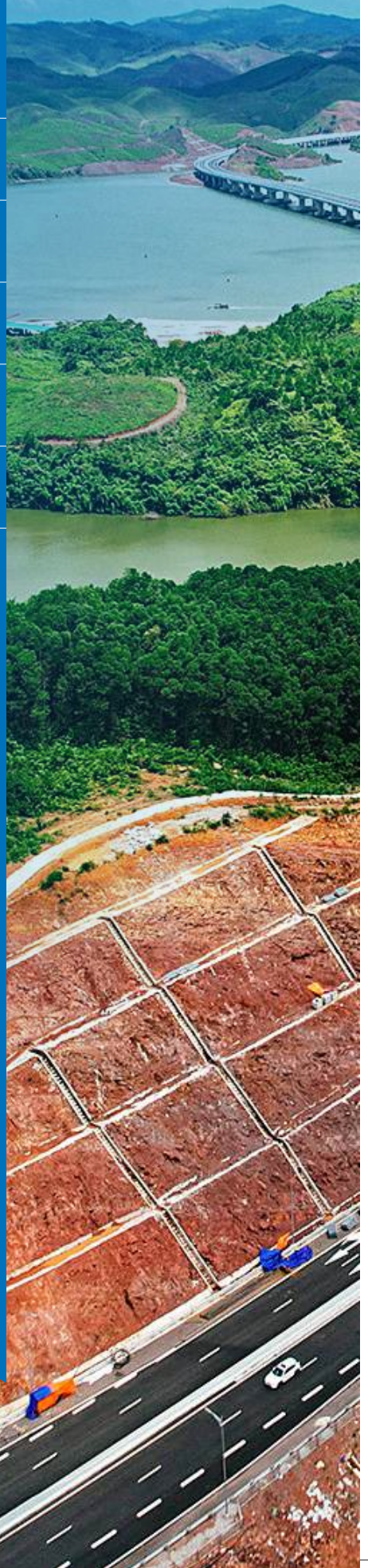

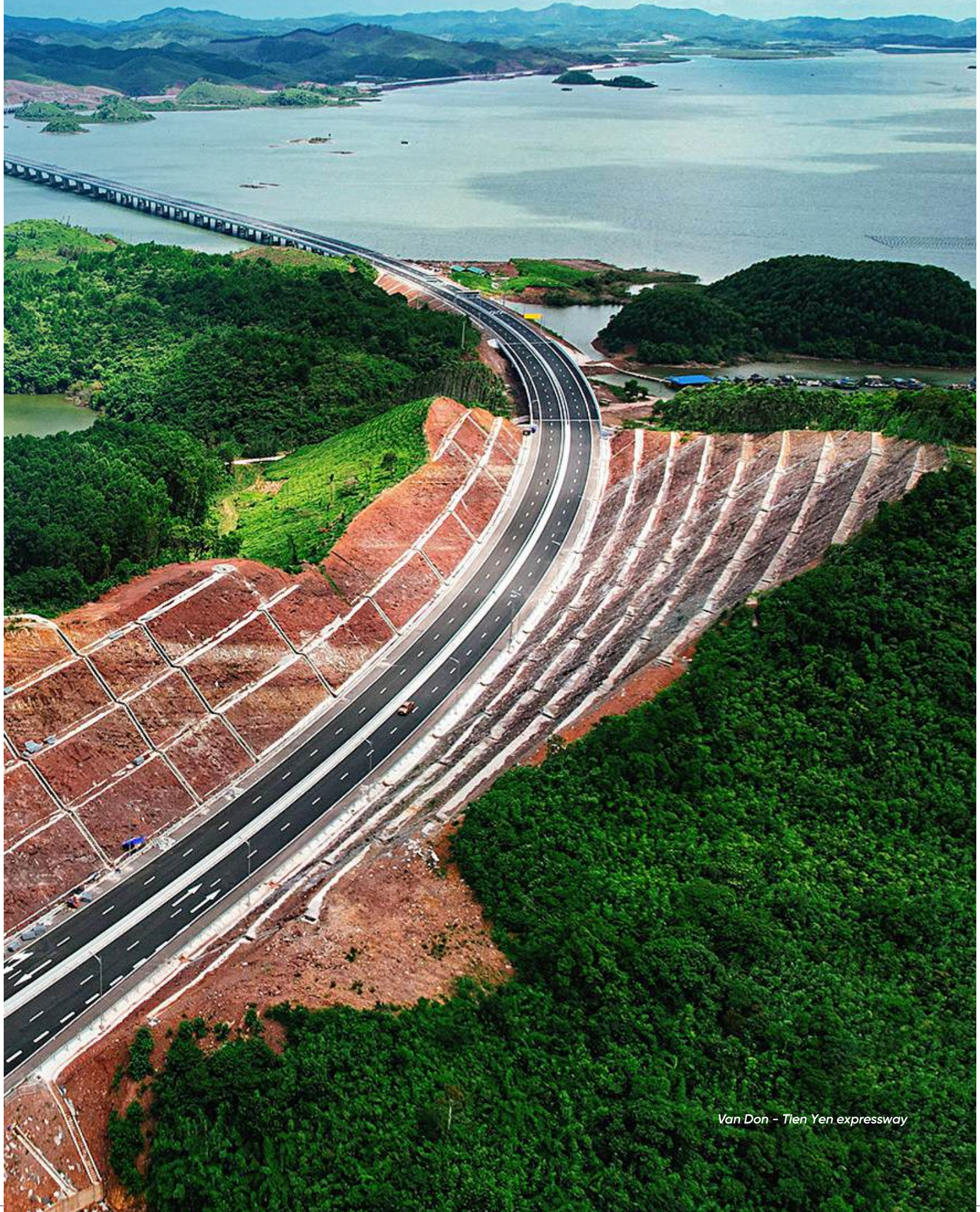

Van Don - Tien Yen expressway

HUNG YEN FACTORY



Area: 15,000 sqm

Highest load capacity of pot bearings produced:

34,500 kN

*Pot bearings
exported to the Philippines*

Maximum displacement of expansion joints produced:

350 mm



BRIDGE BEARINGS
1,500 - 1,800
sets/month

NOISE BARRIERS
10,000
sqm/month

PRODUCTION LINE CAPACITY
OF MAIN PRODUCTS

EXPANSION JOINTS
1,200 - 1,300
m/month

STEEL STRUCTURES
200
tons/month



HUNG YEN FACTORY

MACHINES & EQUIPMENT





CNC lathe machine



CNC oxy-gas cutting machine



CNC Plasma cutting machine



Drilling machine



Lathe machine



Milling machine



Shot blasting machine



CNC turning machine

BAC NINH FACTORY



Area: 52,000 sqm

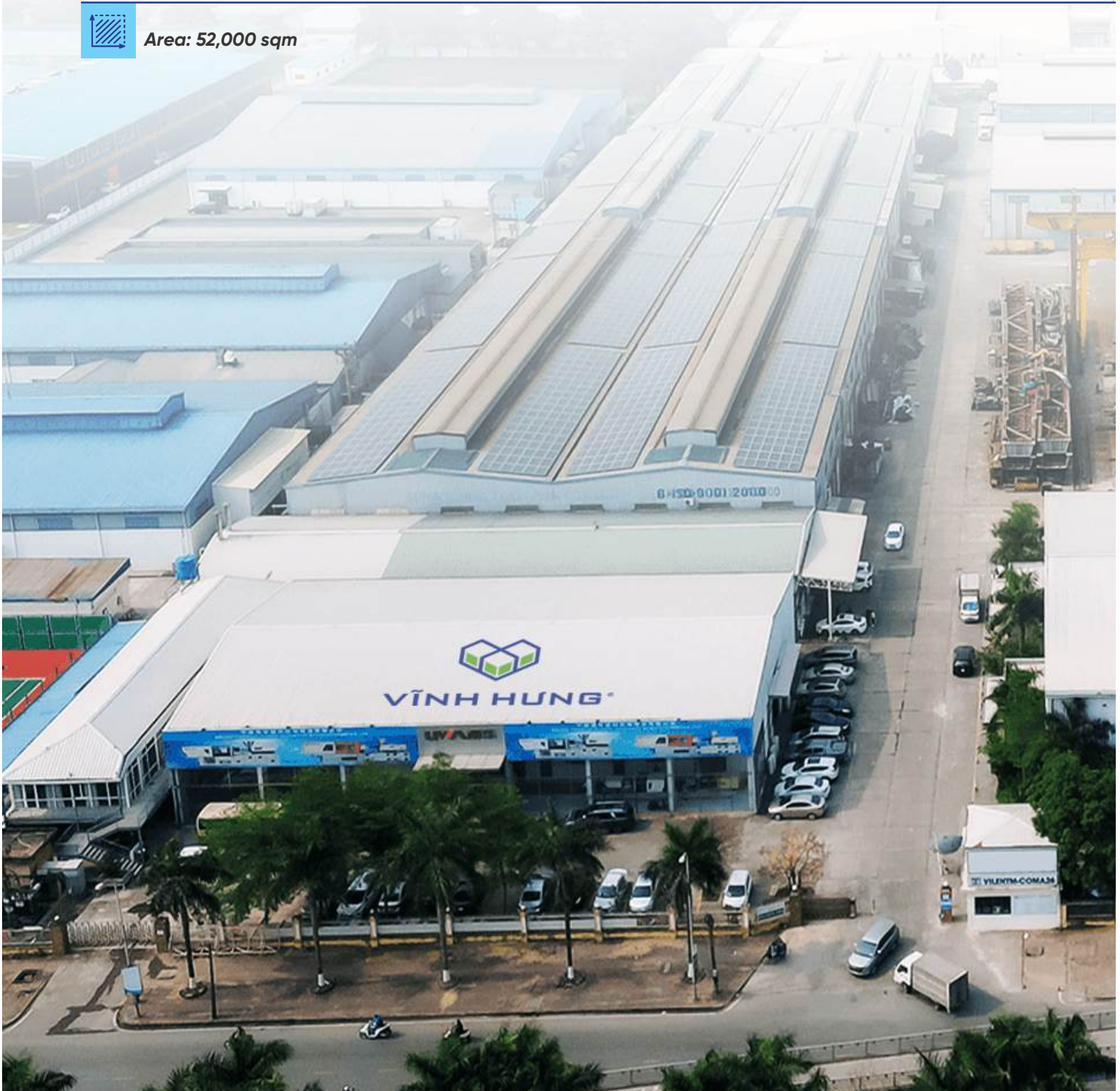

STEEL BRIDGES AND
STEEL BOX GIRDERS

OTHER STEEL STRUCTURES
FOR TRANSPORTATION
CONSTRUCTION

STATION STEEL STRUCTURES
AND ROOF COVERING

PRODUCTION LINE CAPACITY OF MAIN
PRODUCTS

2,000
tons/month

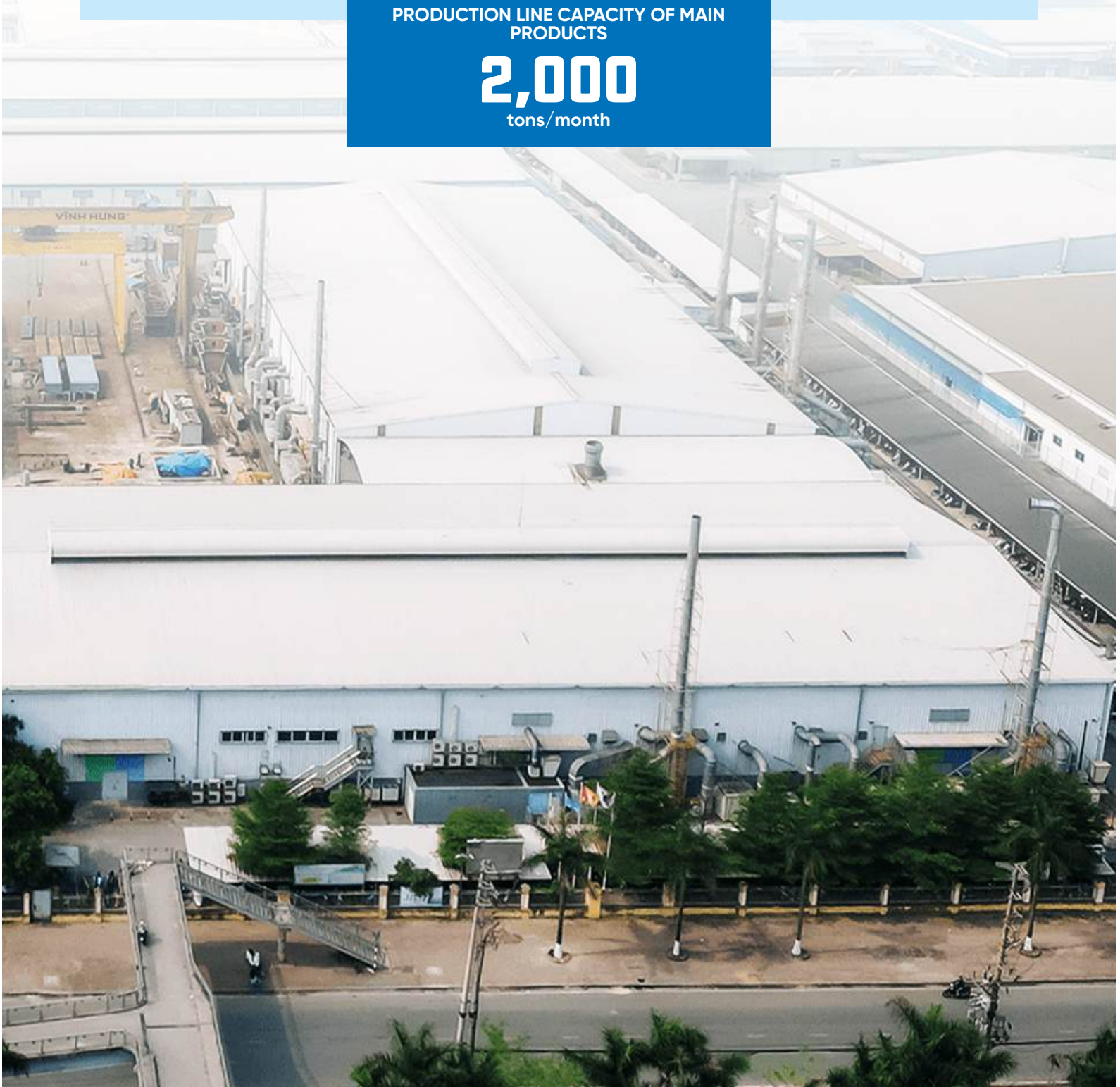

BAC NINH FACTORY

MACHINES & EQUIPMENT



Spiral welded pipe manufacture lines



Metal particle blasting cabinets



Automatic gate welding machines



CNC automatic corrugated iron cutting machines



CNC automatic drilling machines



CNC automatic punching machines



Cranes of 32 tons and 60 tons



Section iron belding machines



Automatic beam assembling machines

HO CHI MINH FACTORY



Area: 6,000 sqm

PRODUCTION LINE CAPACITY
OF MAIN PRODUCTS

ELASTOMERIC BEARINGS

100
tons/month

OTHER RUBBER PRODUCTS





Rubber vulcanizing machines



Rubber vulcanizing machines



Laminating machines



Rubber press machines



Rubber moulding press machines



Testing machines and equipment

DESIGN AND MANUFACTURING STANDARDS



QUALITY CONTROL

Vinh Hung has invested in an in-house laboratory equipped with state-of-art machines for quality control during the whole manufacturing process, from input materials to finished products.

1 Materials



2 Fabrication & manufacturing

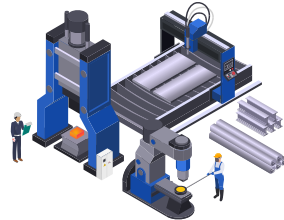

3 Products



Laboratory



4 Packaging and shipping



QUALITY CONTROL EQUIPMENTS



Anchor testing systems and finished prestressed cables



10 kN tension testing



Magnetic particle test equipment



Ozone aging test chamber



Determine the heat aging



Coating thickness gauge



Automatic adhesion tester



Sample maker cutting machine



Bearing testing 15,000 kN



1000 kN tension testing



Metal hardness tester



Digital liquid densitometer



Ultrasonic testing machine



Shore hardness tester



Surface roughness tester

TYPICAL EXPRESSWAY PROJECTS

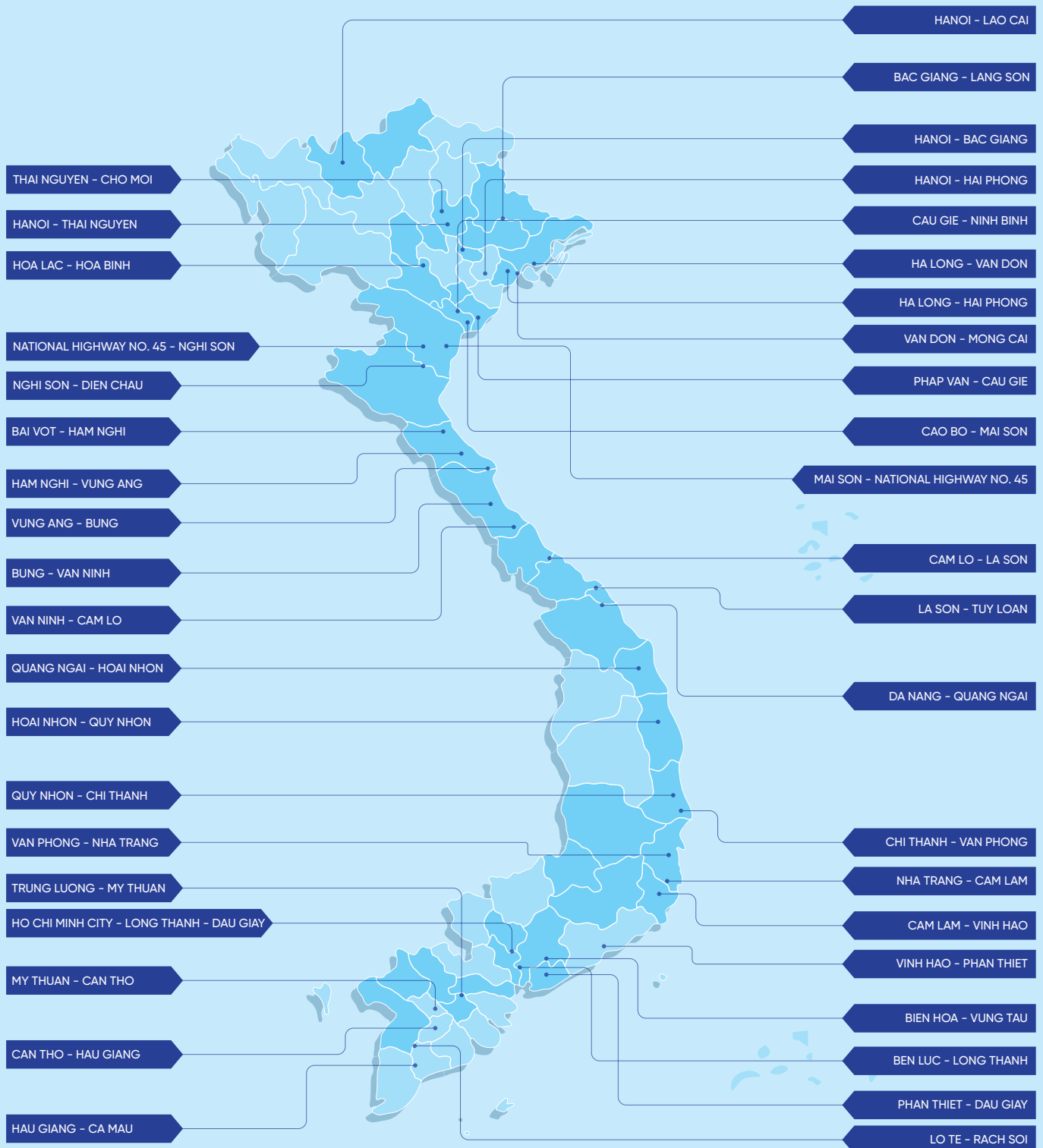

Illustration of over 40 expressways in Vietnam that Vinh Hung participates in supplying materials or construction

Products manufactured by Vinh Hung have been exported to countries in the Southeast Asian: The Philippines, Brunei, Indonesia, Thailand, and Cambodia.



TYPICAL EXPORT PROJECTS



THE PROJECT OF MALOLOS-CLARK RAIL WAY
THE PHILIPPINES



NLEX-SLEX CONNECTOR ROAD PROJECT
THE PHILIPPINES



THE PROJECT OF A LONGEST BRIDGE IN THE PHILIPPINES - CEBU-CORDOVA LINK EXPRESSWAY
THE PHILIPPINES



THE PROJECT OF BUILDING A LONGEST SEA - CROSSING BRIDGE IN SOUTHEAST ASIA
BRUNEI

TYPICAL EXPORT PROJECTS



MOTORWAY ONNUCH - LADKRABANG
THAILAND

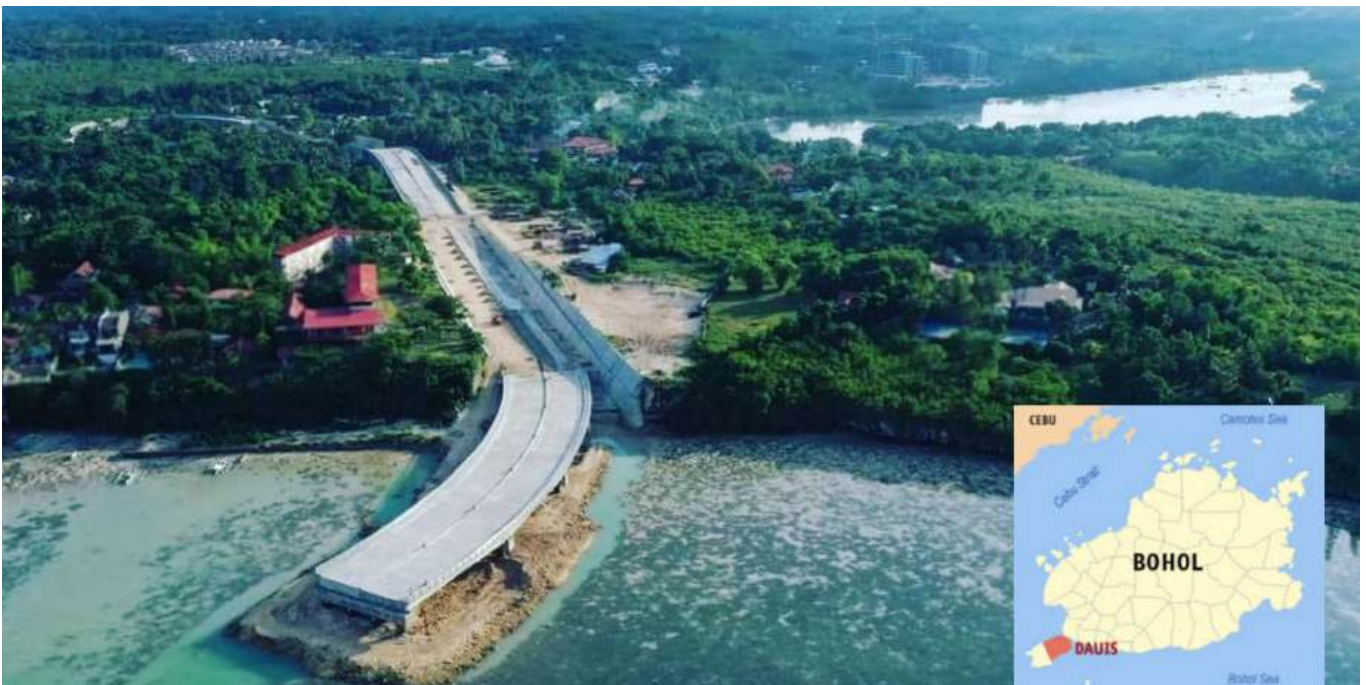

THE NEW PANGLAO-TAGBILARAN OFFSHORE BRIDGE CONNECTOR
THE PHILIPPINES



MOTORWAY BANG KHUN THIAN – BAN PHAEO LINE (M82)
THAILAND

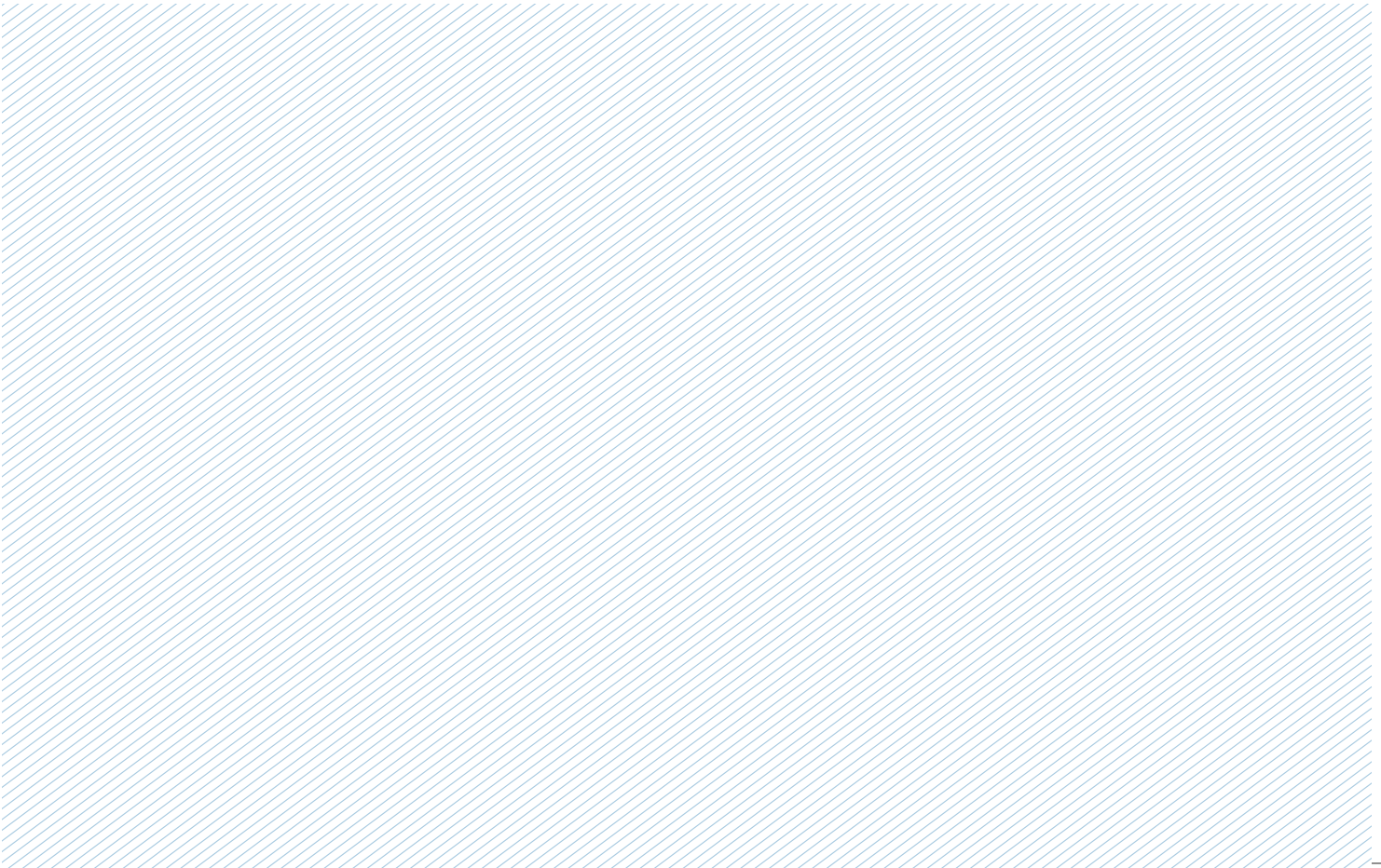

WE WORK WITH GLOBAL PARTNERS



VINH HUNG has been trusted and chosen by global partners to manufacture and supply products for remarkable projects in the Philippines, Brunei, Indonesia, Thailand.



WHY CHOOSING US?

Quality control:

All stages of manufacturing are supervised by QA/QC team and ready to be checked by third-party at customers' requests.

1

International certificates:

Vinh Hung JSC manufactures all products with management system ISO 9001:2015, ISO 14001:2015, EN 1090-2 (EXC3), ISO 3834-2

2

Professional team:

Our experienced sales supervisors, R&D and technical engineers, skilled workers make a perfect team to support you from the beginning to the end of project.

3

On time delivery:

With modern machinery, highly trained engineers and workers, we commit to manufacture and delivery on schedule.

4

Dedicated services:

We can provide you with a customized service that meets your specific needs.

5

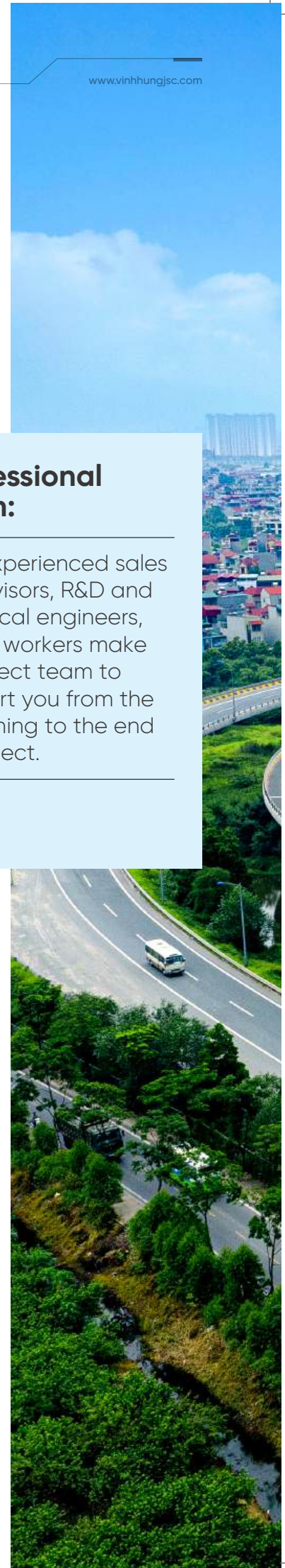



VINH HUNG TRADING, CONSULTING AND CONSTRUCTION JOINT STOCK COMPANY

HEAD OFFICE

Address: Lot BT2, no. 49, Bac Linh Dam Area,
Hoang Liet Ward, Hoang Mai District, Hanoi, Vietnam
Phone: 84-24-3540 2468, 84-24-3540 1771

HO CHI MINH CITY BRANCH

Address: Room 304, DC Building, No. 111D Ly Chinh Thang Street,
Ward 7, District 3, Ho Chi Minh City, Vietnam
Phone: 84-28-3526 4188

DA NANG REPRESENTATIVE OFFICE

Address: Room 303, Building No. 309 Nguyen Huu Tho Street,
Hoa Cuong Bac Ward, Hai Chau District, Da Nang City, Vietnam
Phone: 84-236-367 3366

-
- **HUNG YEN FACTORY:**
Expansion joints, bridge bearings, noise barriers, steel structure fabrication
 - **BAC NINH FACTORY**
Steel structure fabrication
 - **HO CHI MINH CITY FACTORY**
Elastomeric bearings and rubber products

WEBSITE

www.vinhhungjsc.com

EMAIL

kdxk@vinhhungjsc.com

